



## ANEXO I

### MODELOS DETALLADOS DE SECUENCIA, COLABORACIÓN, Y ESTÁTICO DE CLASES

#### SECUENCIA:

#### Write:

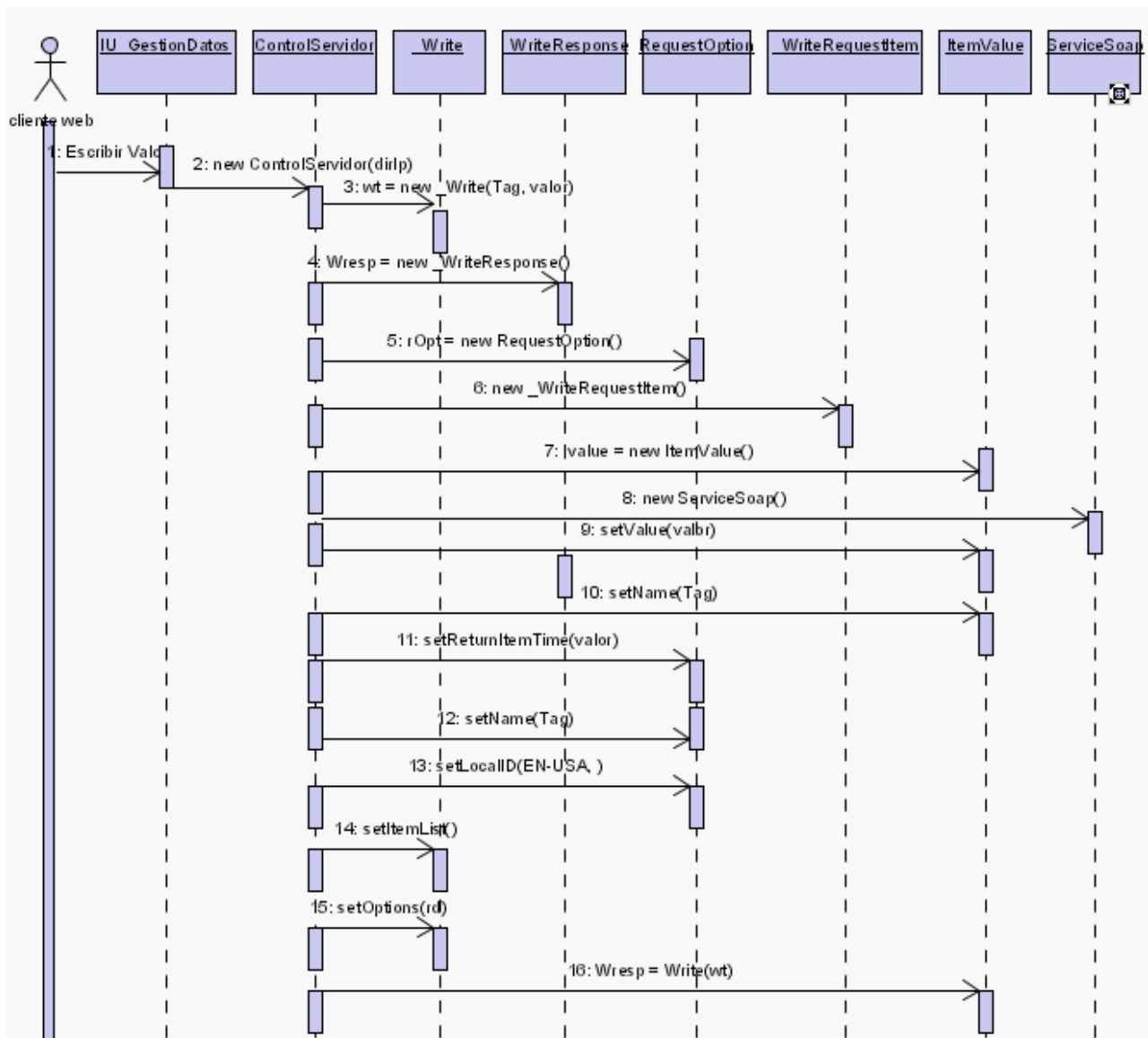



### Read:

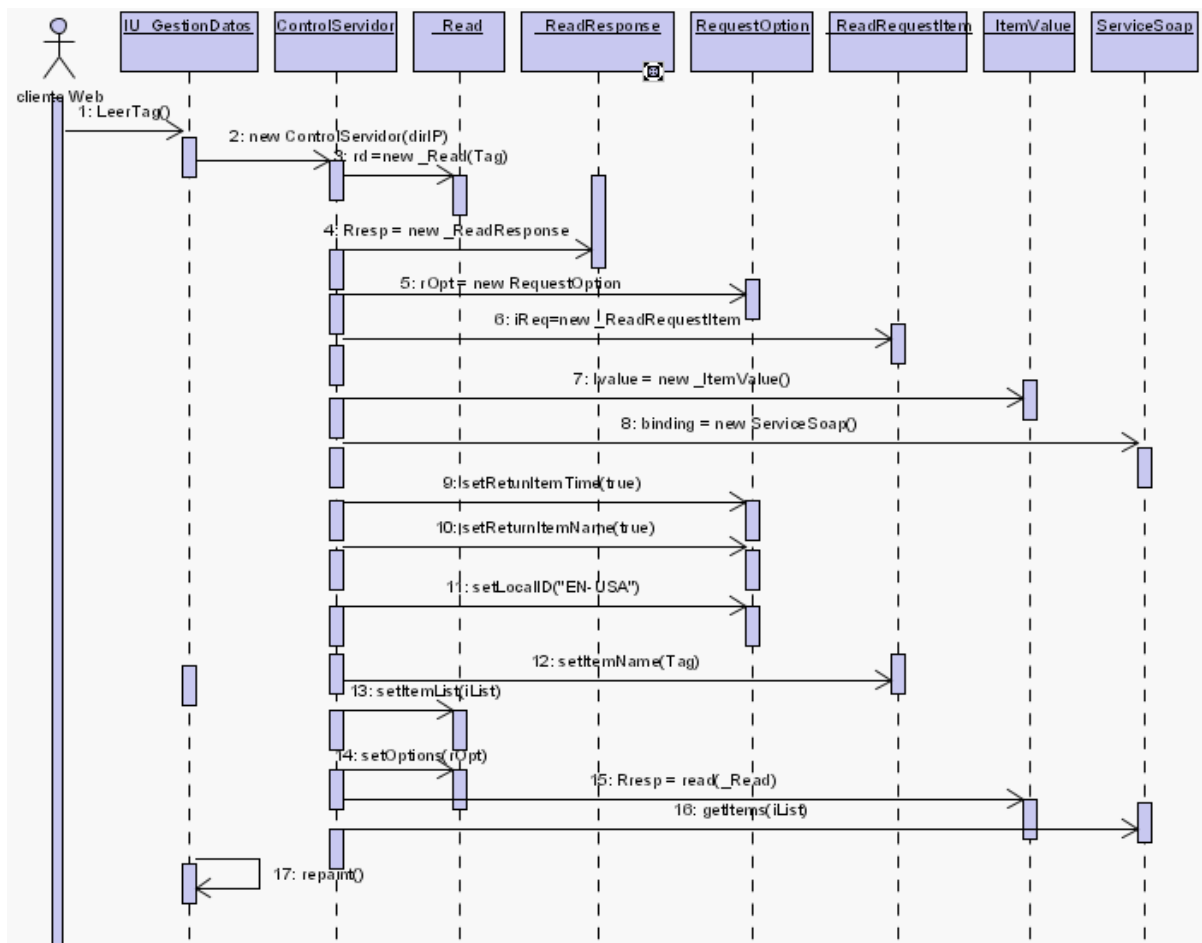

### Browse:

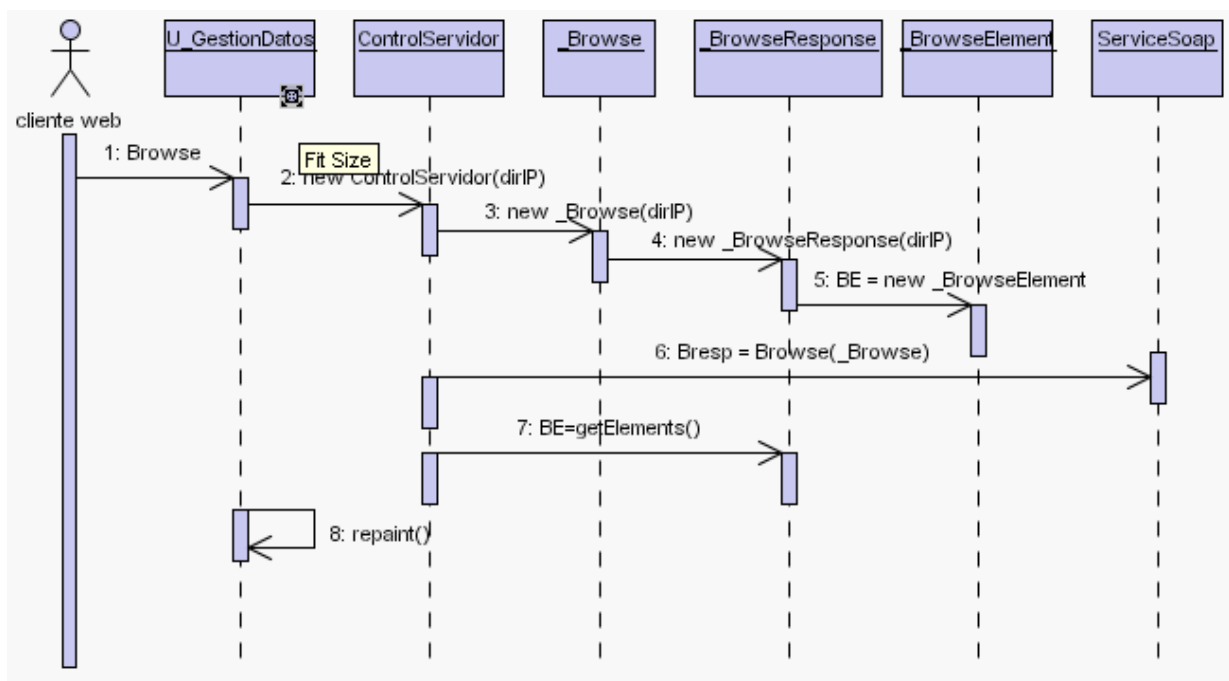



## Agregar Alarmas

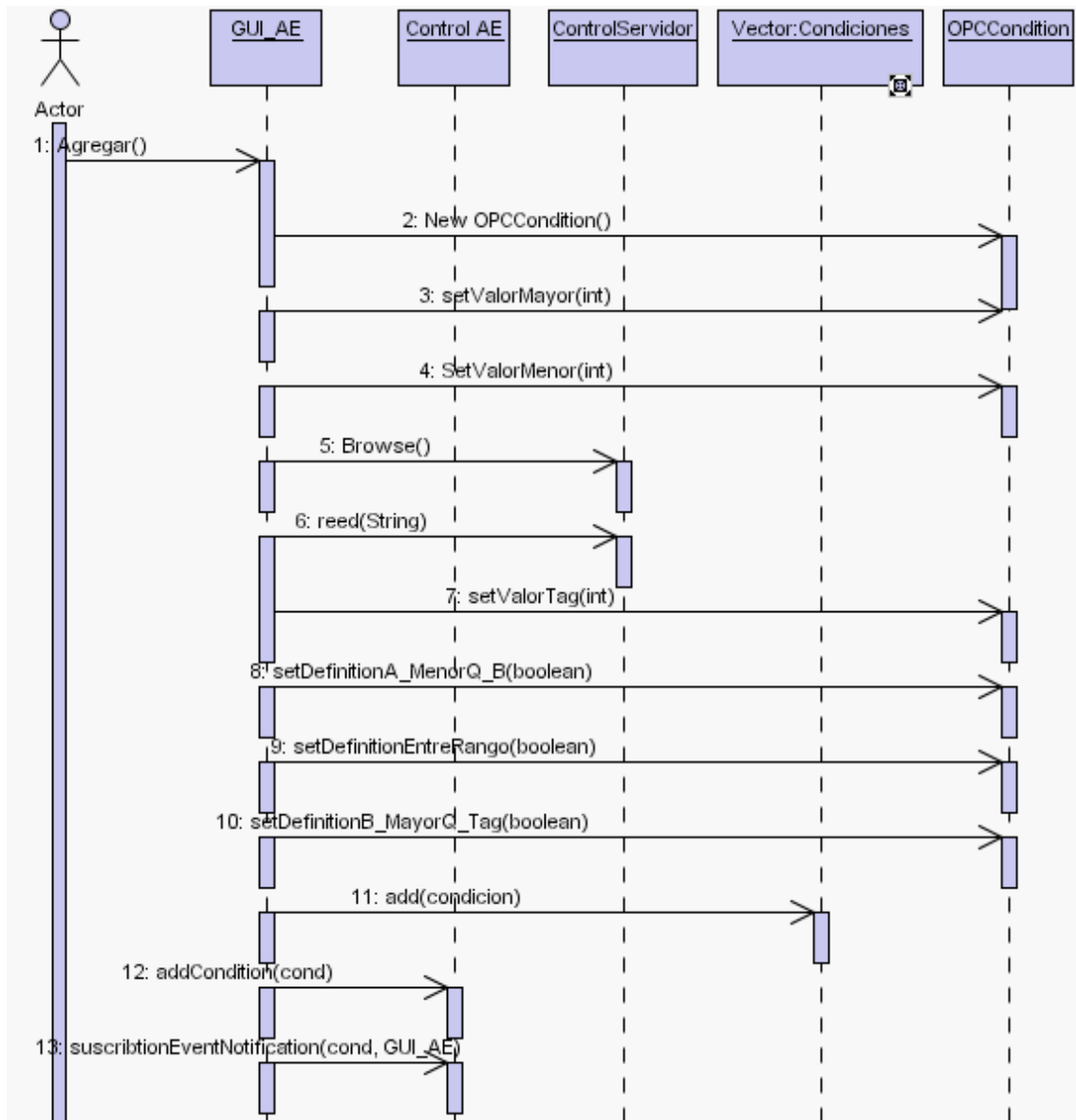



## Ver Alarmas:

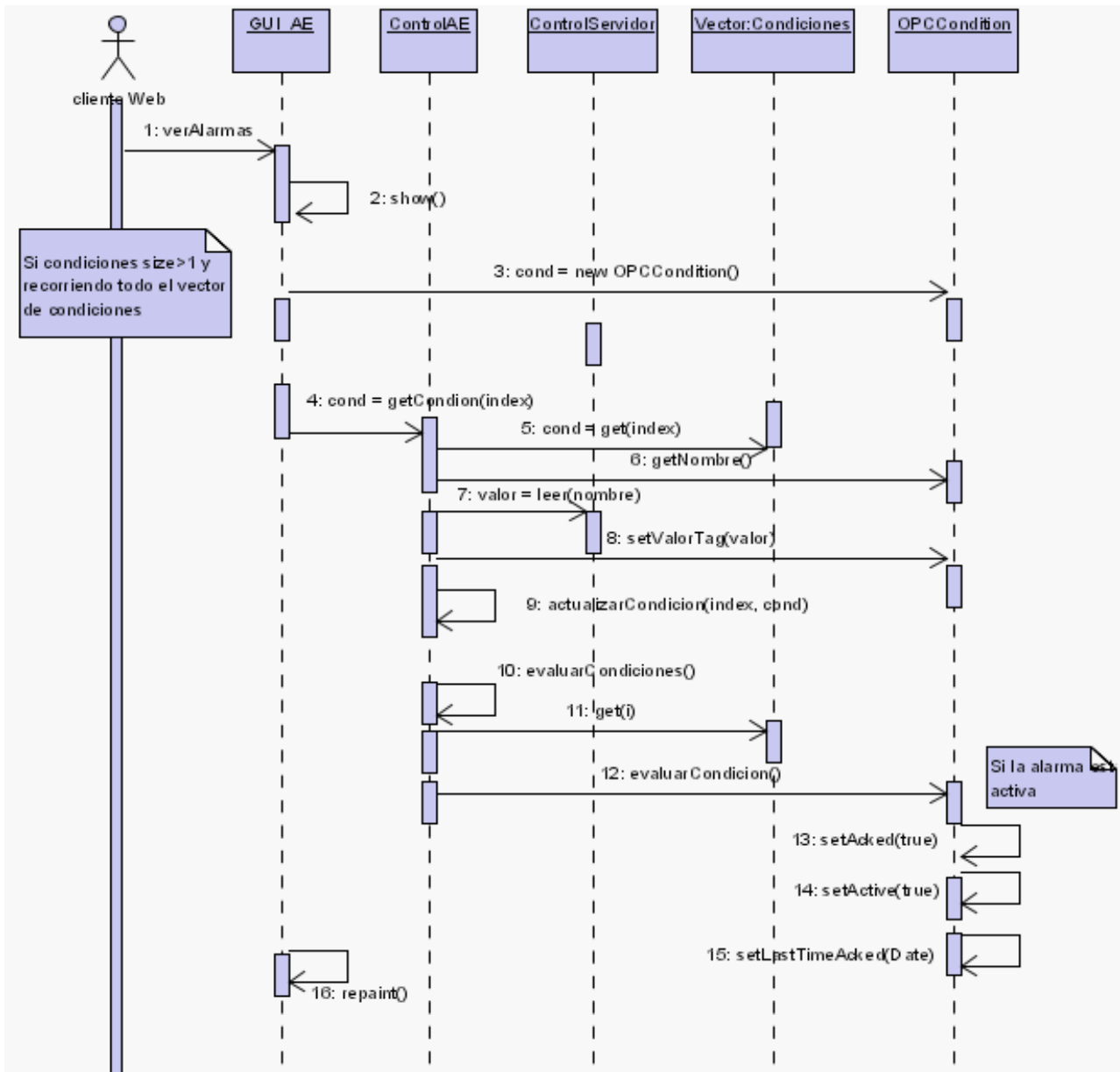



## Ver Detalles

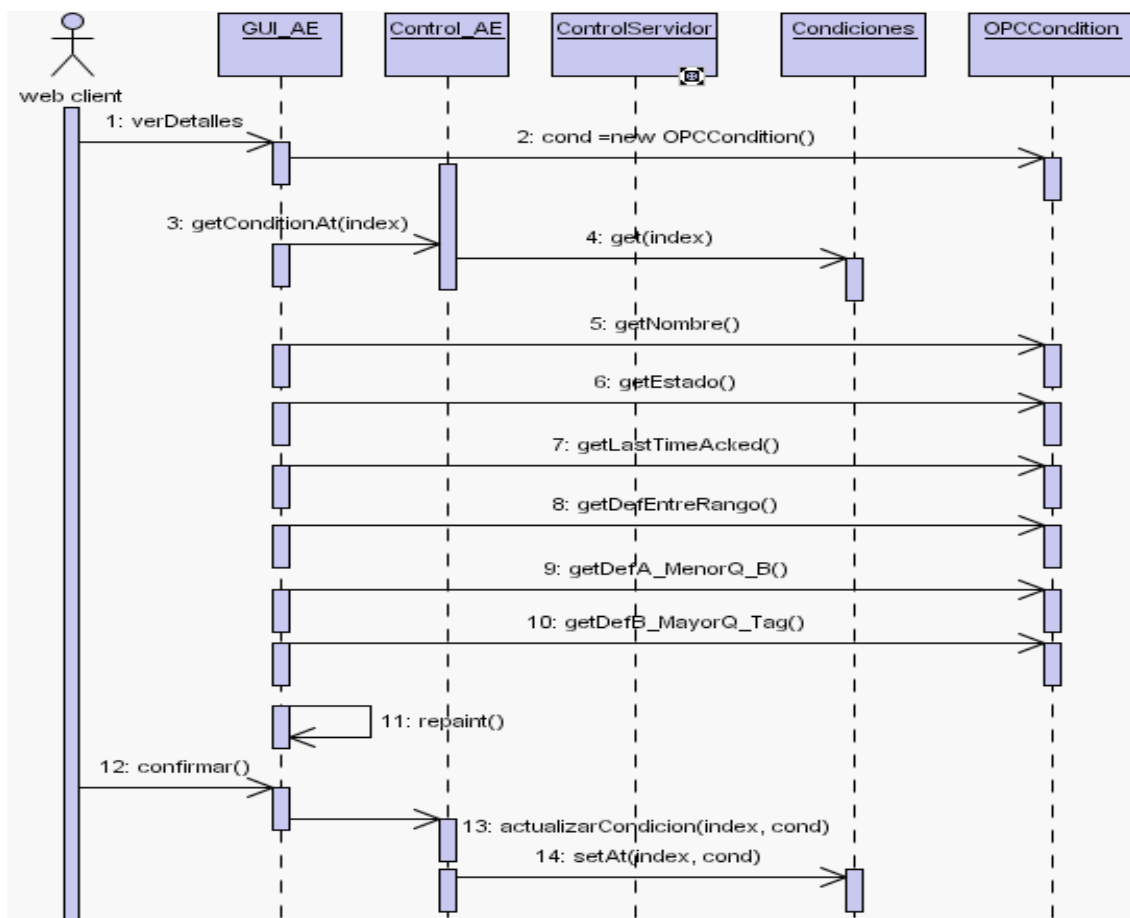

## Almacenar:

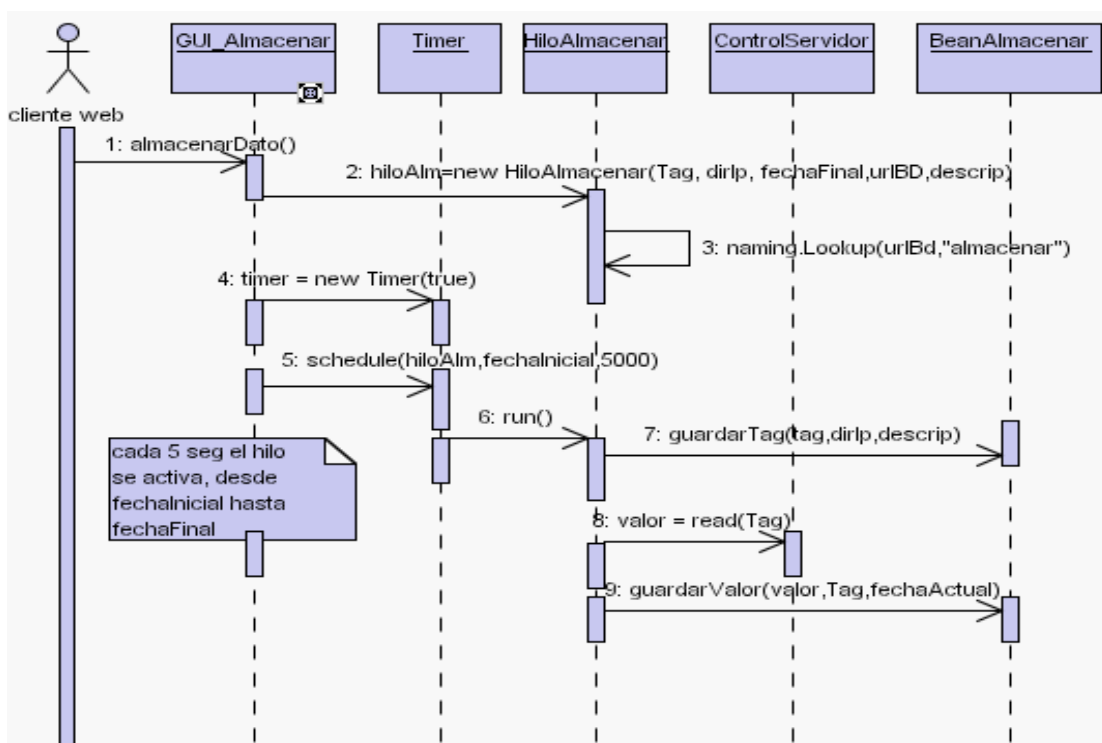



## Diagramas de Colaboración:

### Browse:

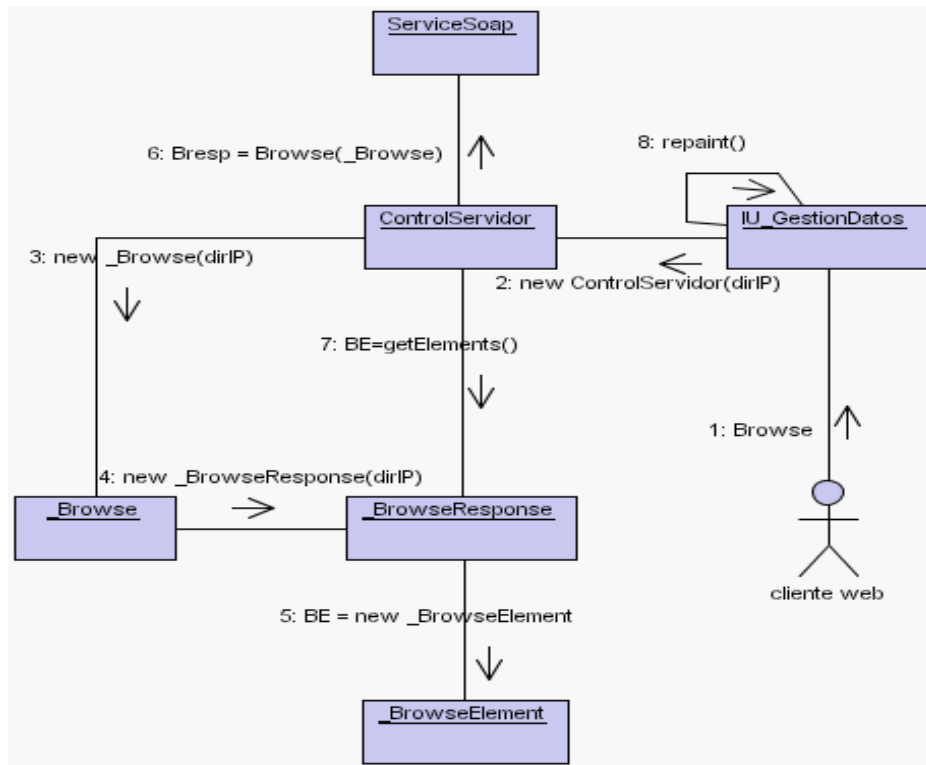

### Read:

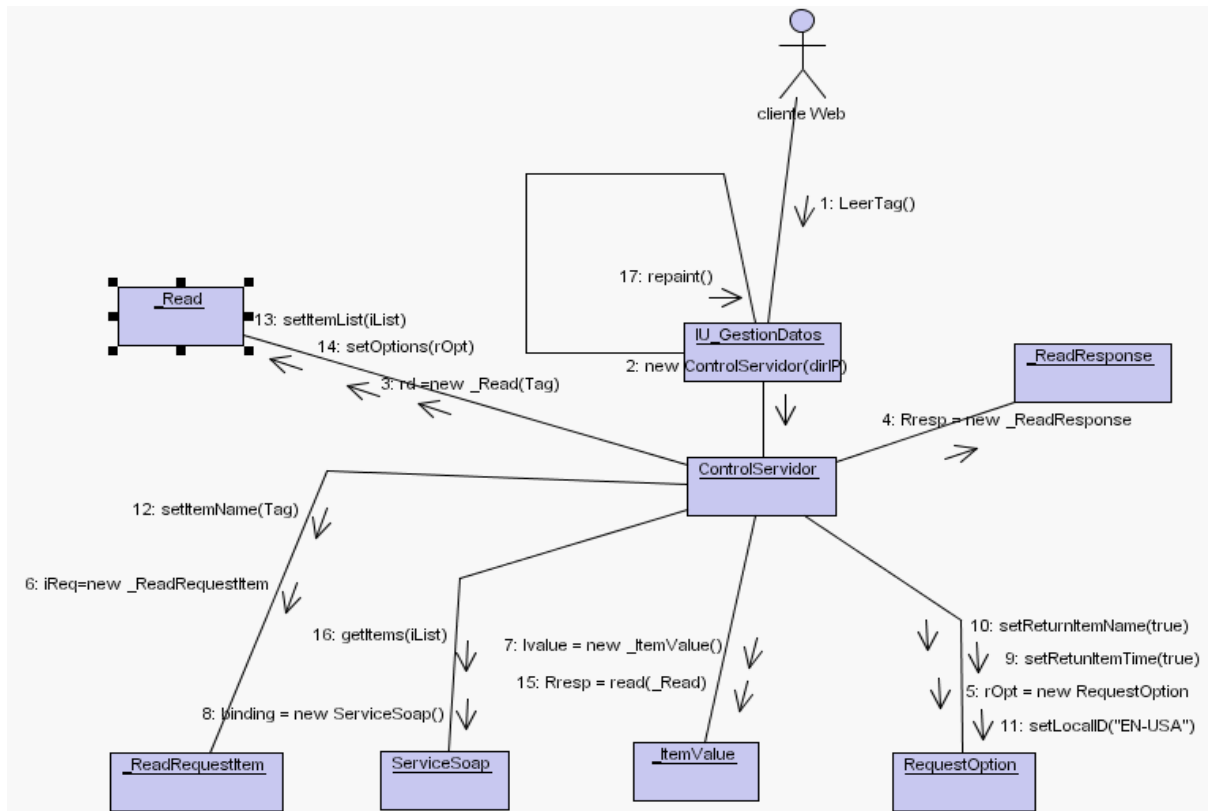



### Write:

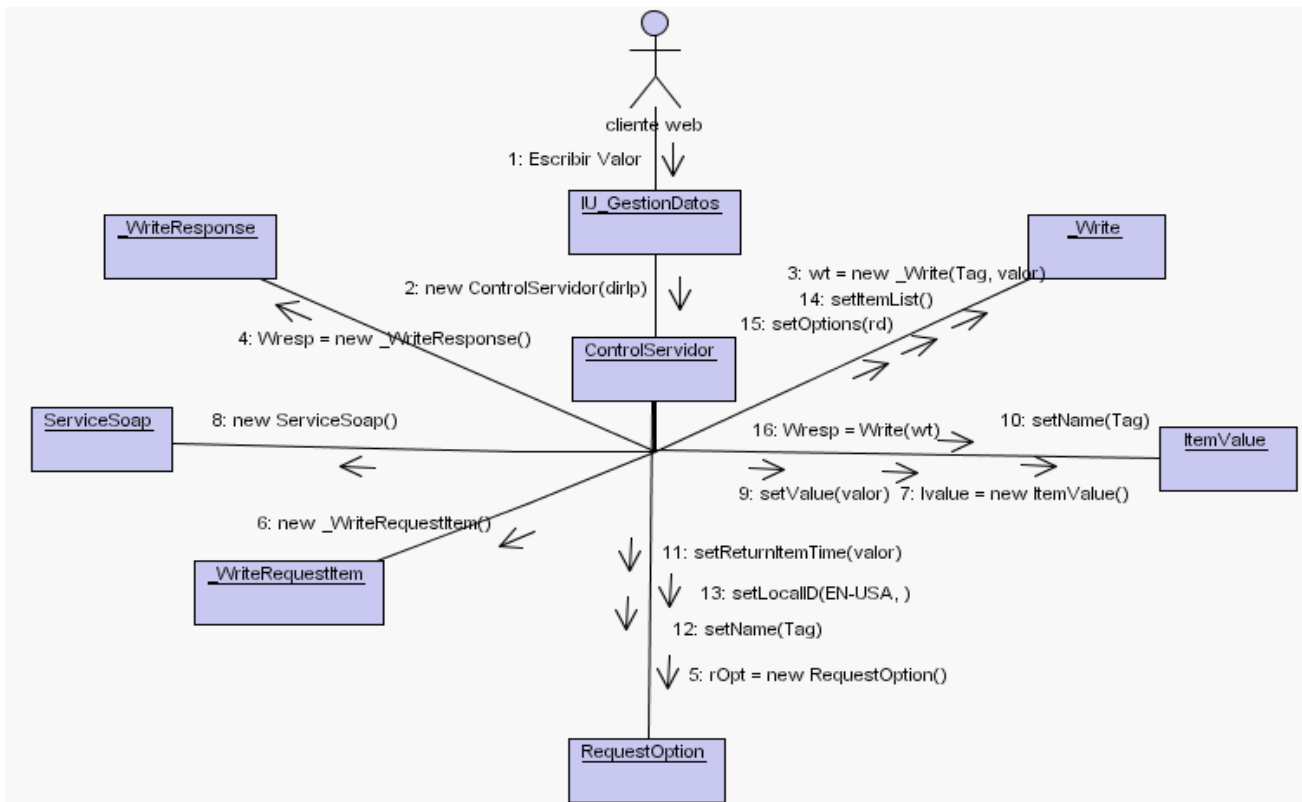

### Agregar Alarmas:

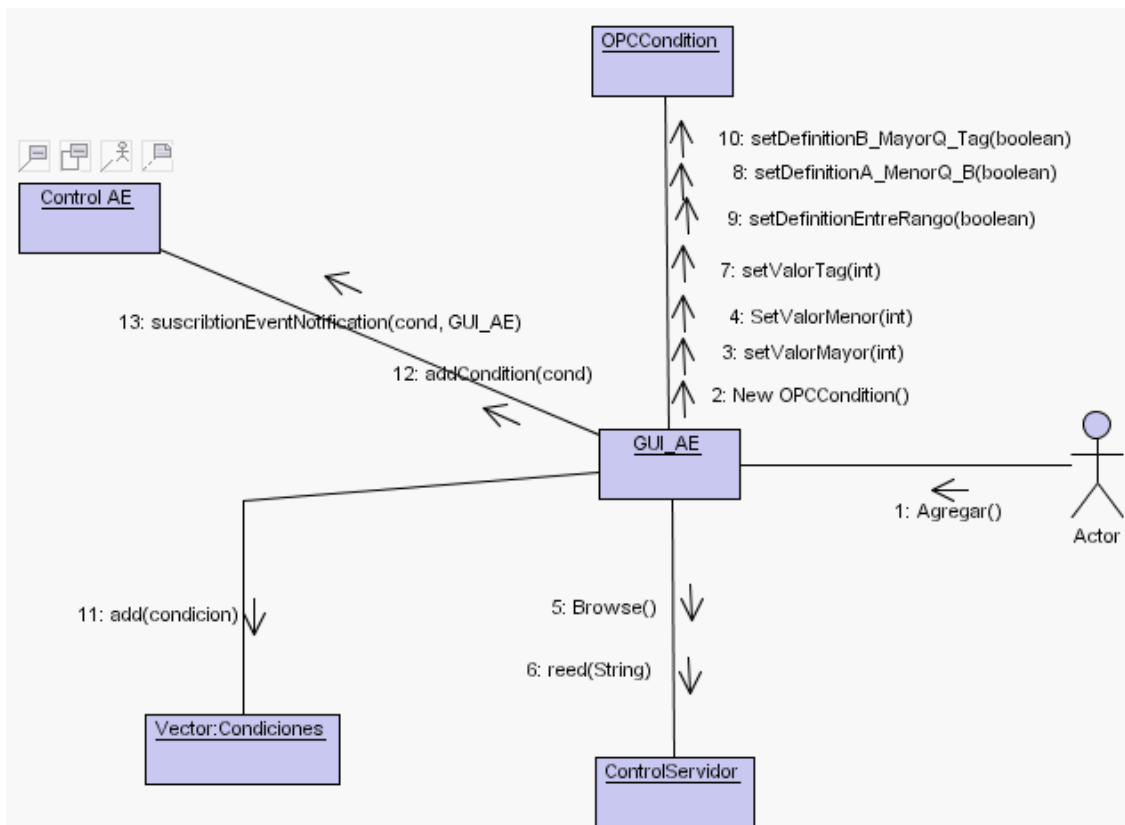



## Ver Alarmas:

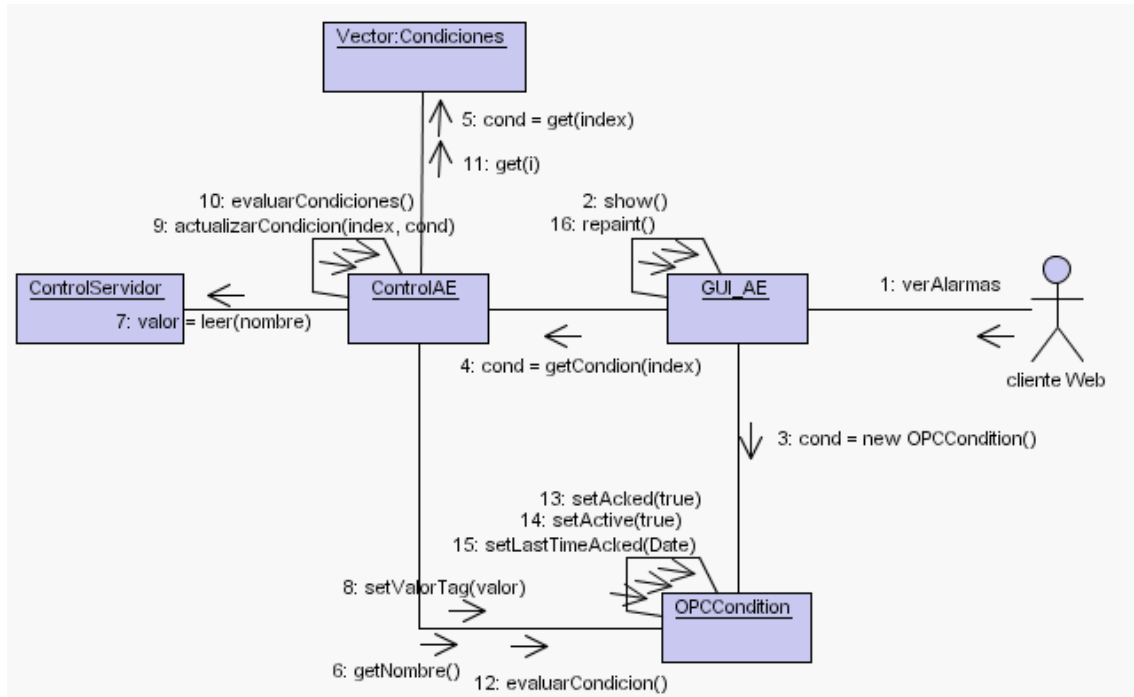

## Ver Detalles:

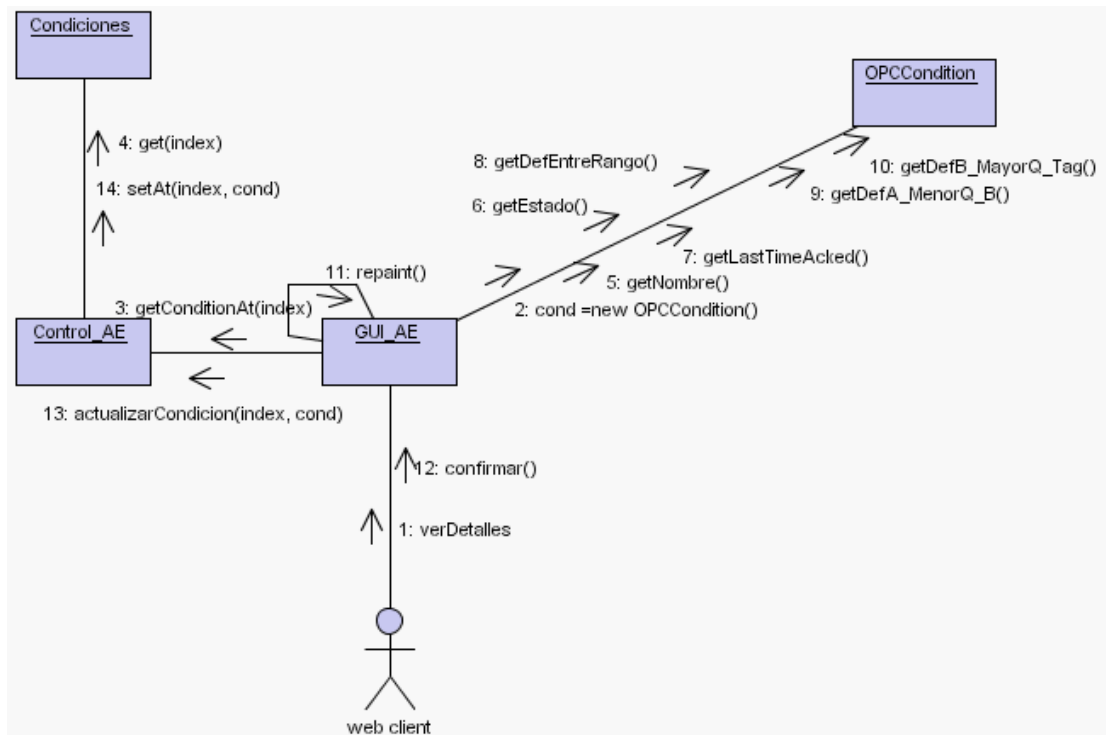





## Almacenar:

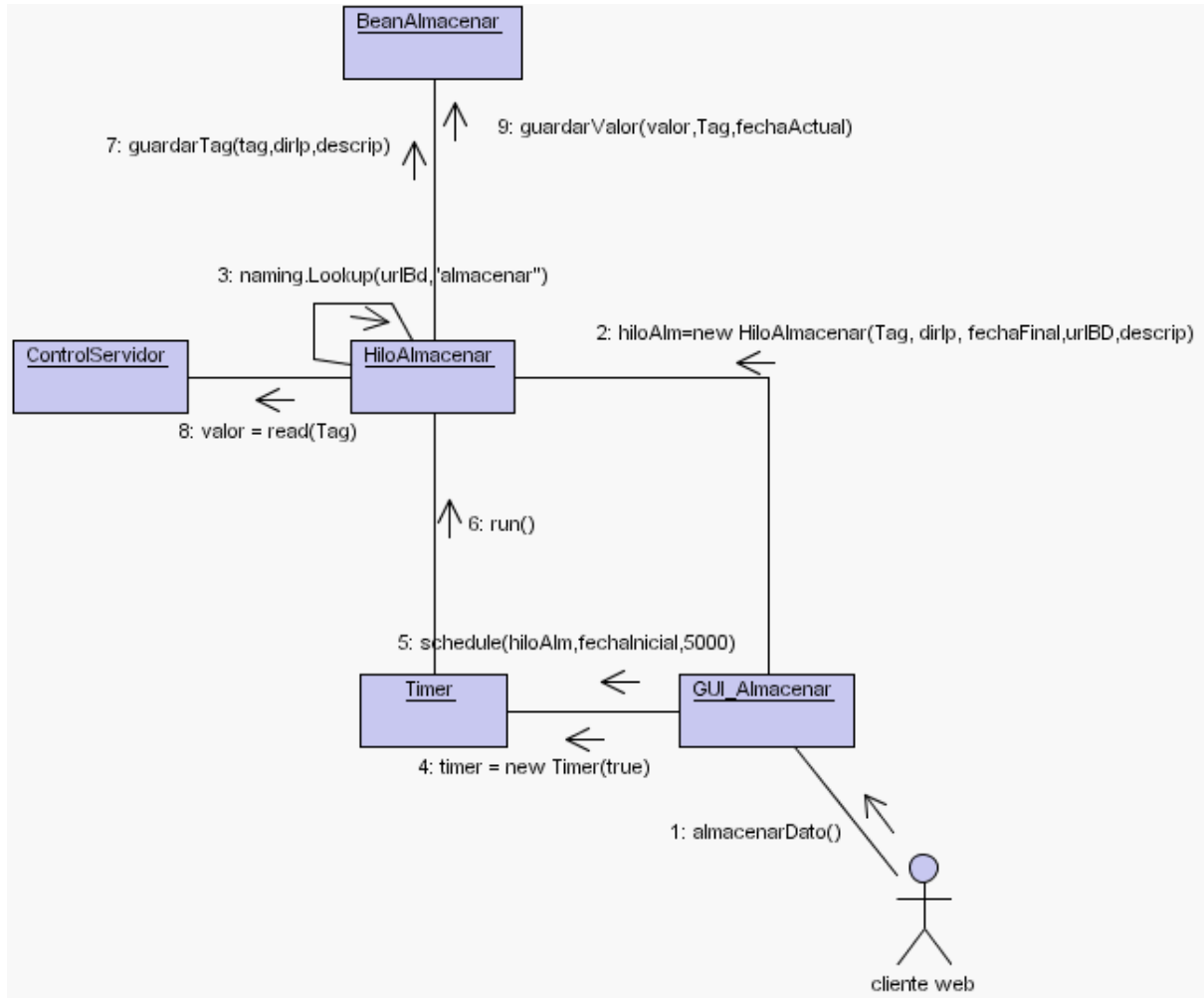



## Diagrama estático de clases:

### Paquete ModeloBD:

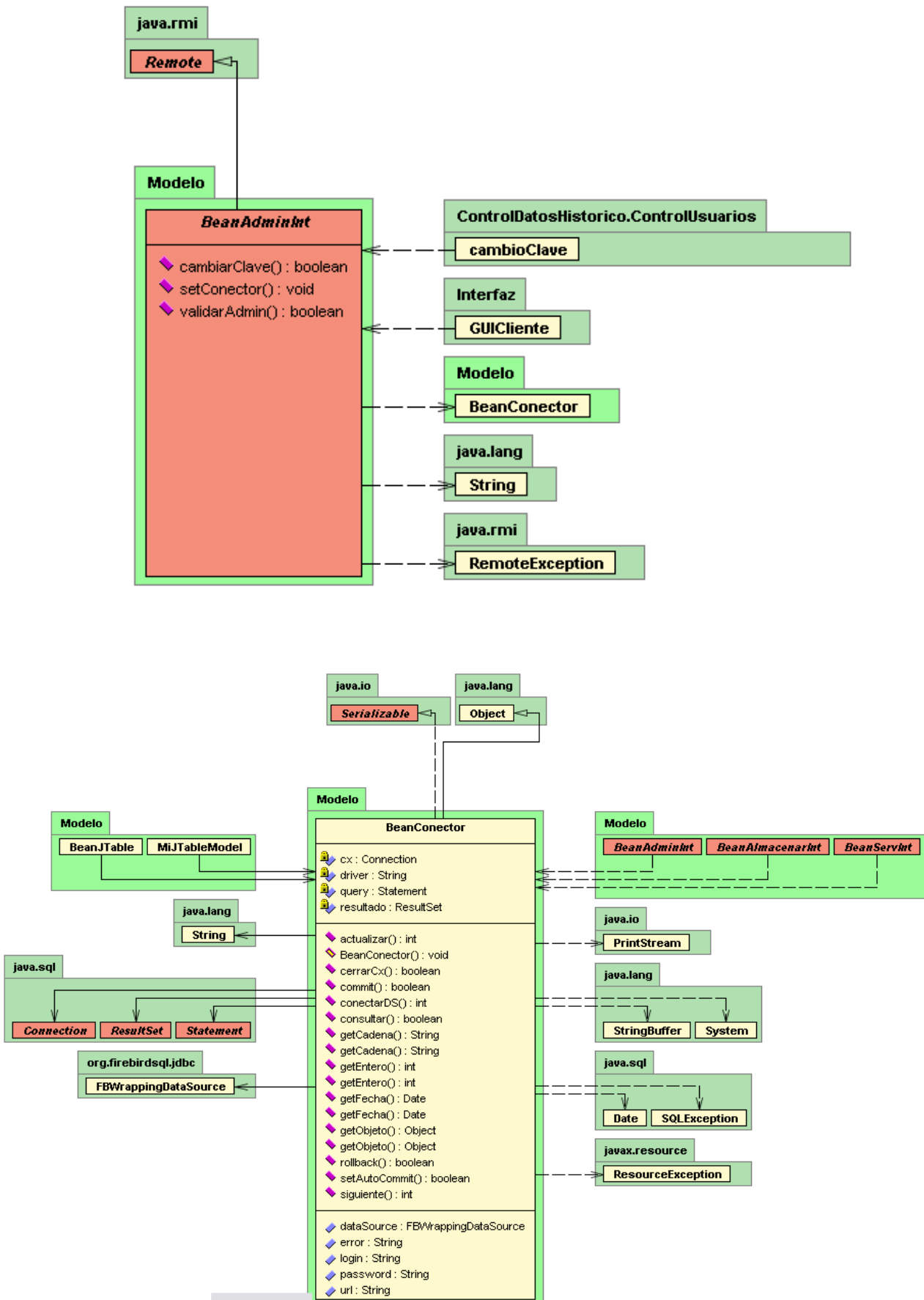

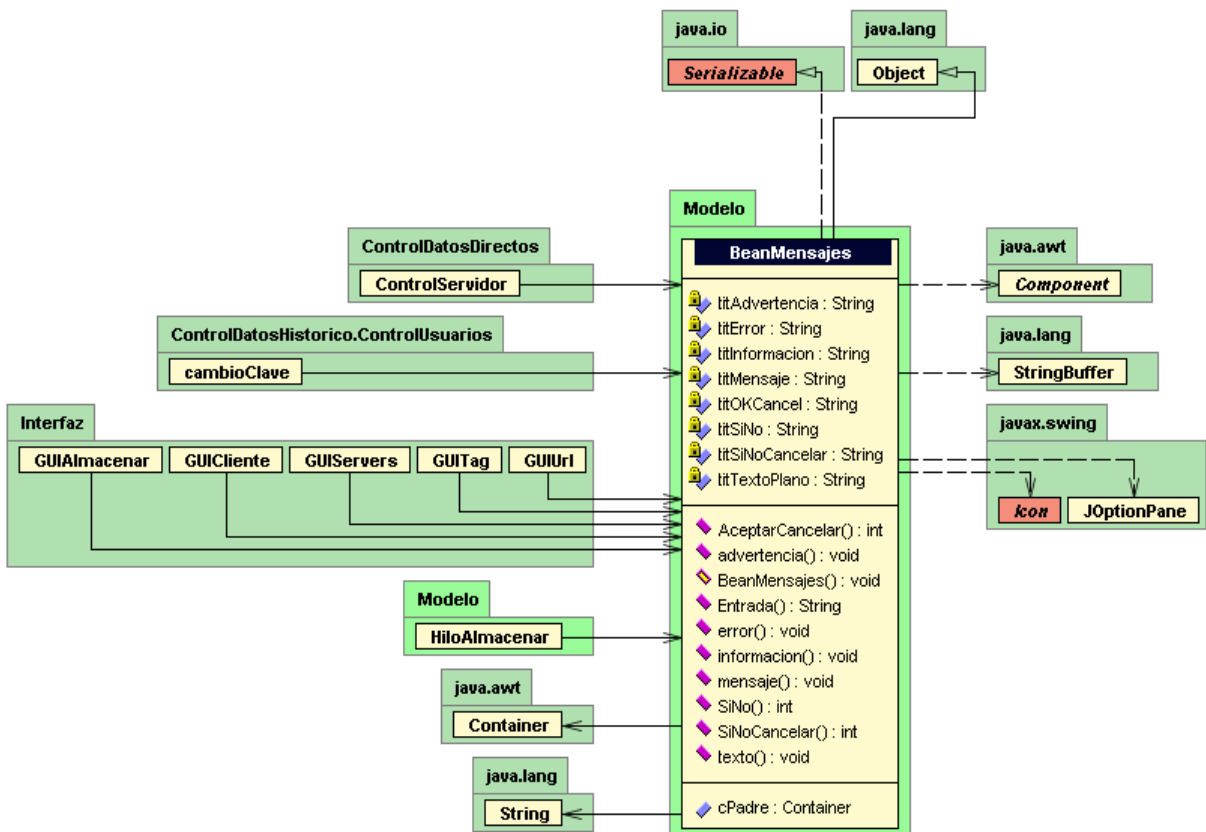
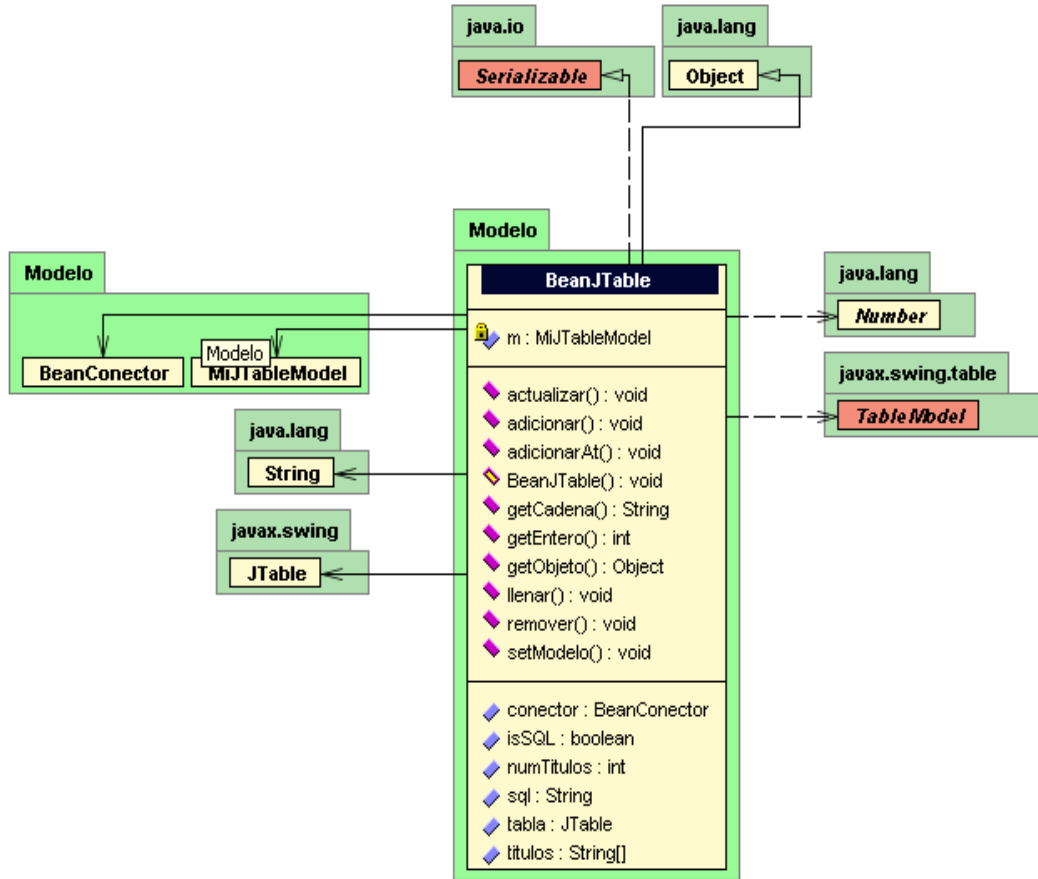

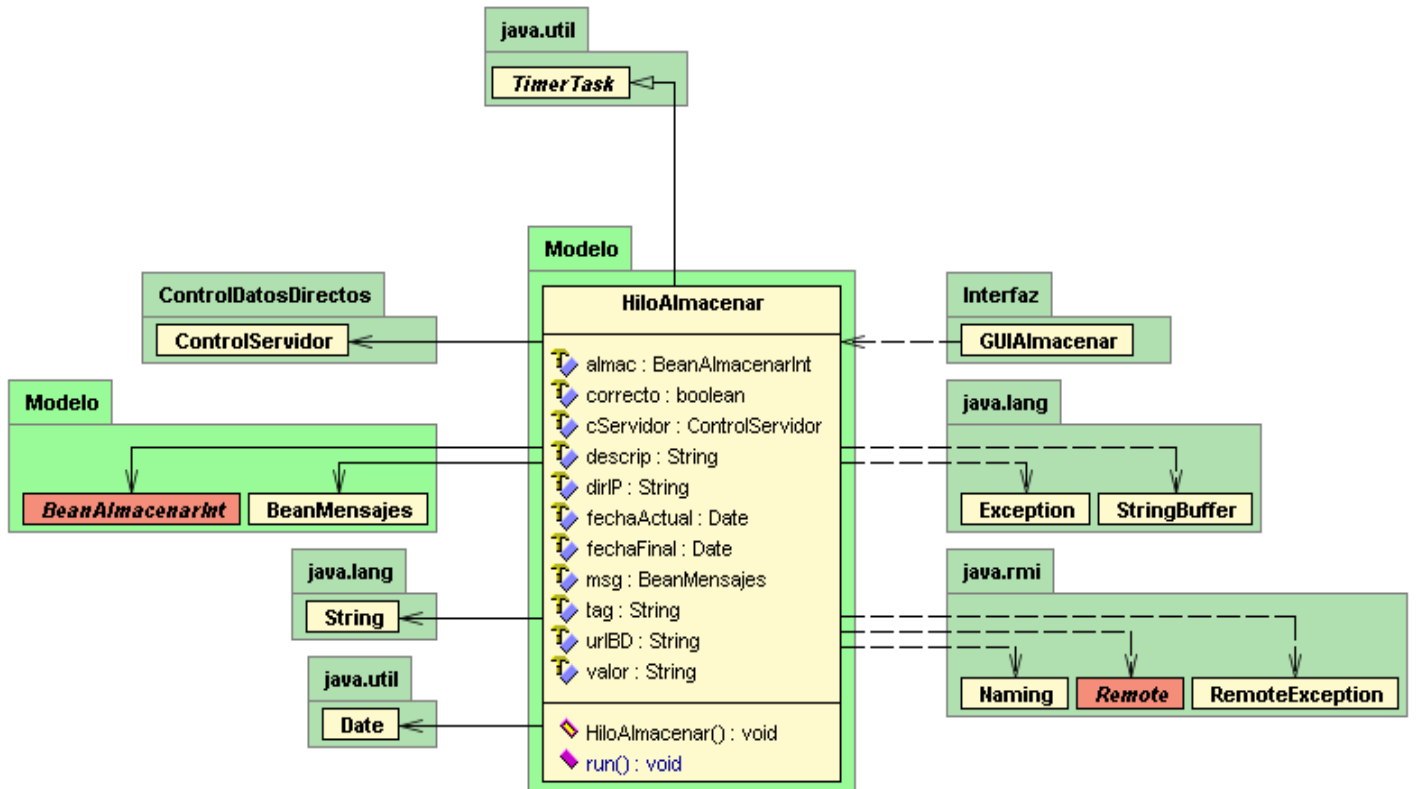
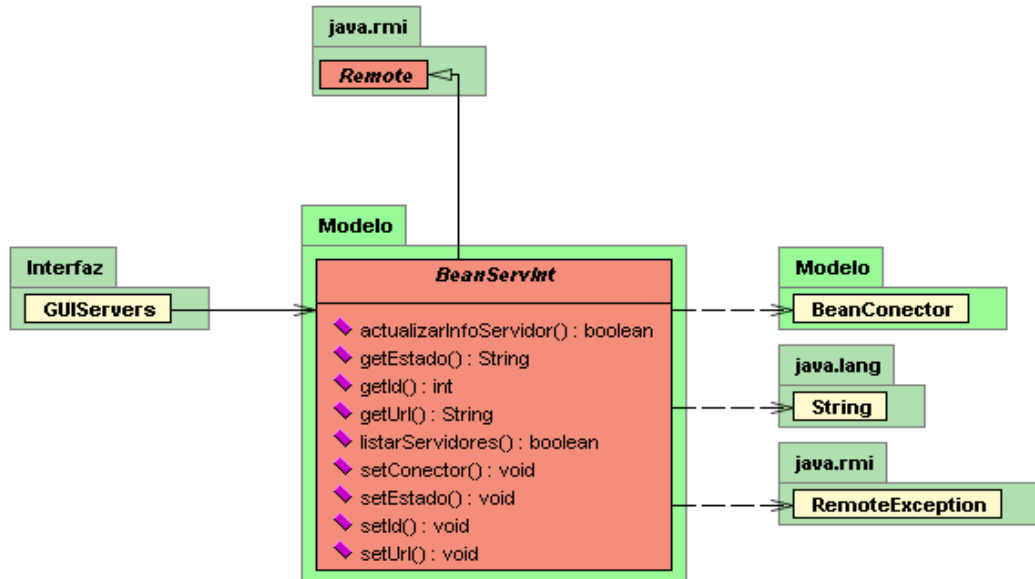

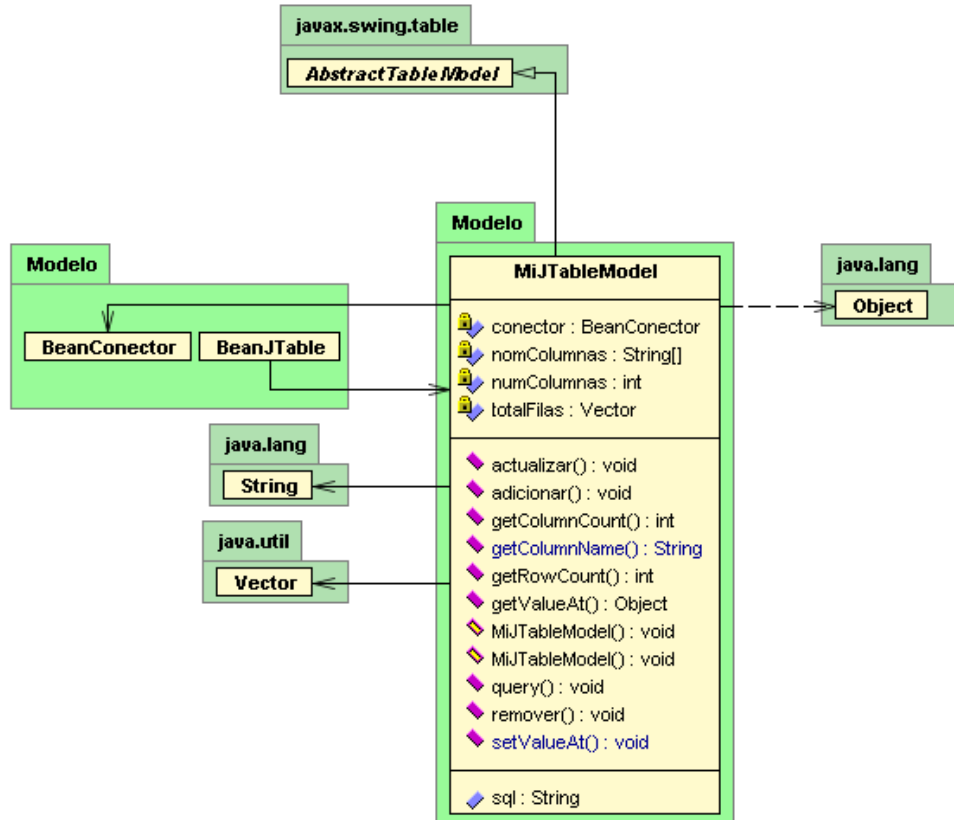

### Paquete ControlBD:

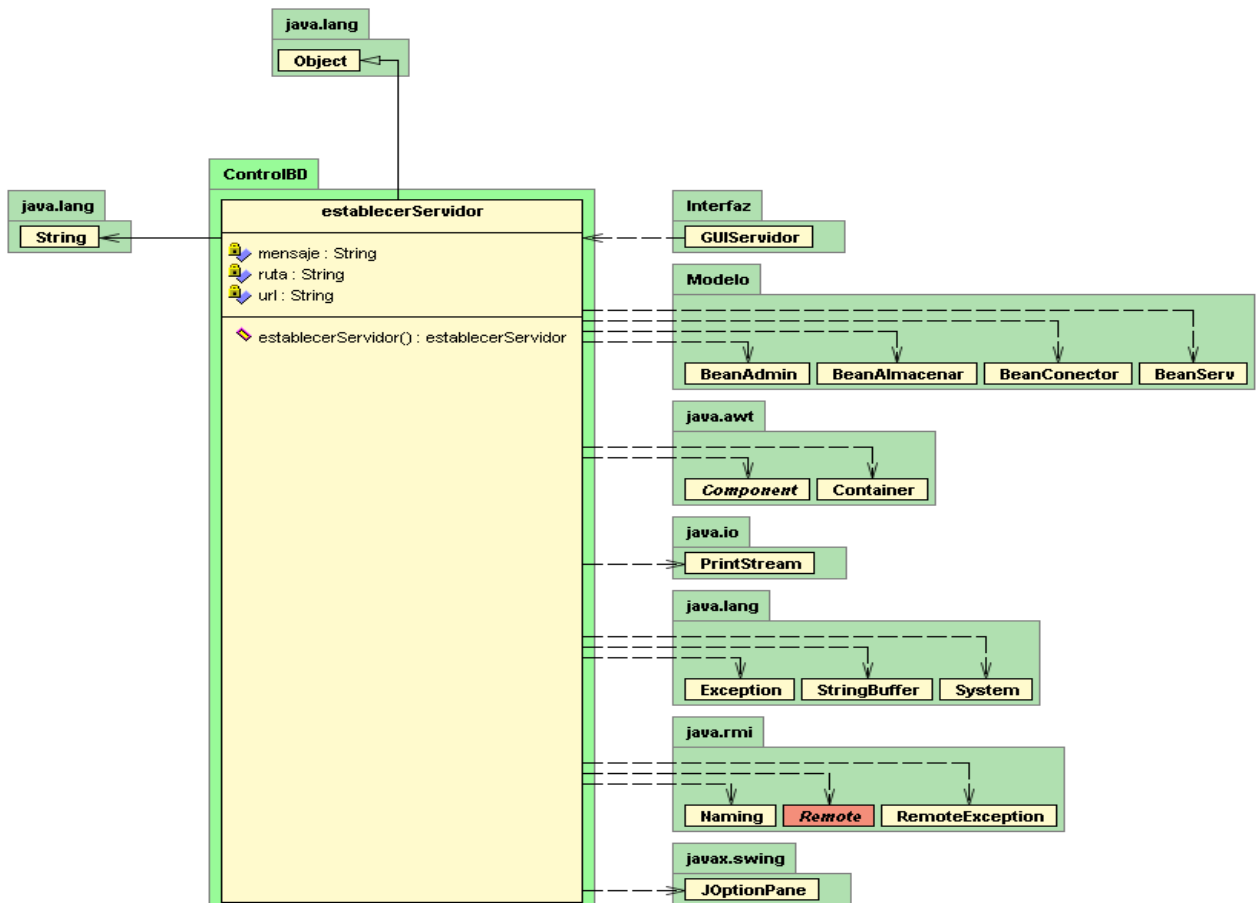

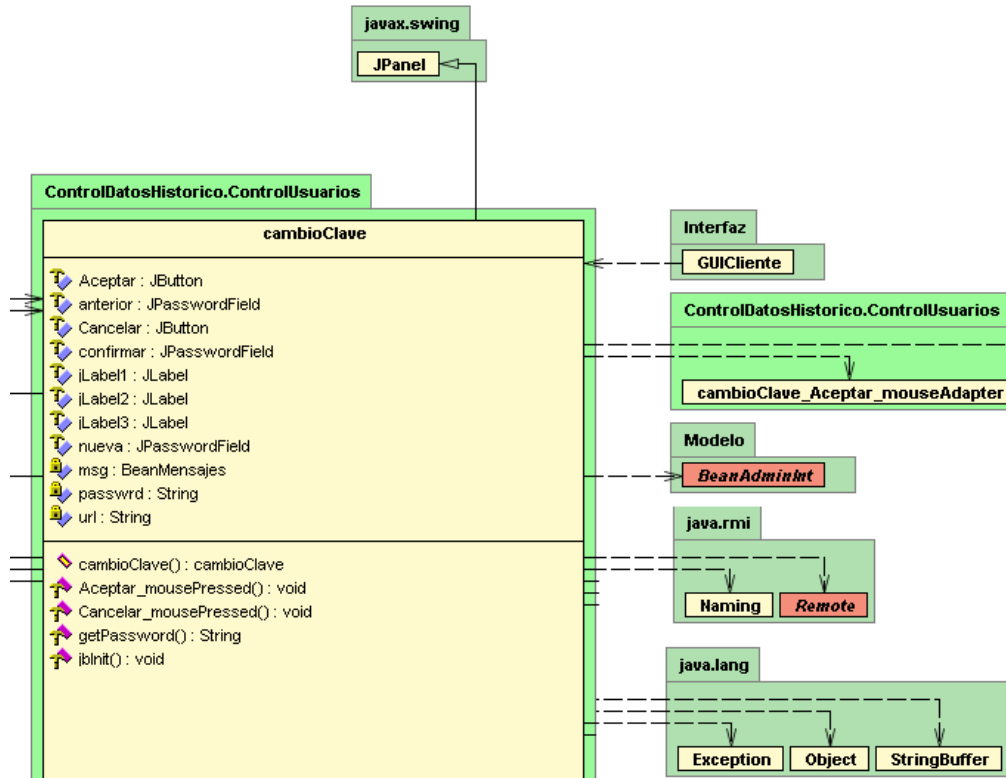

### Paquete ControlDatosDirectos:

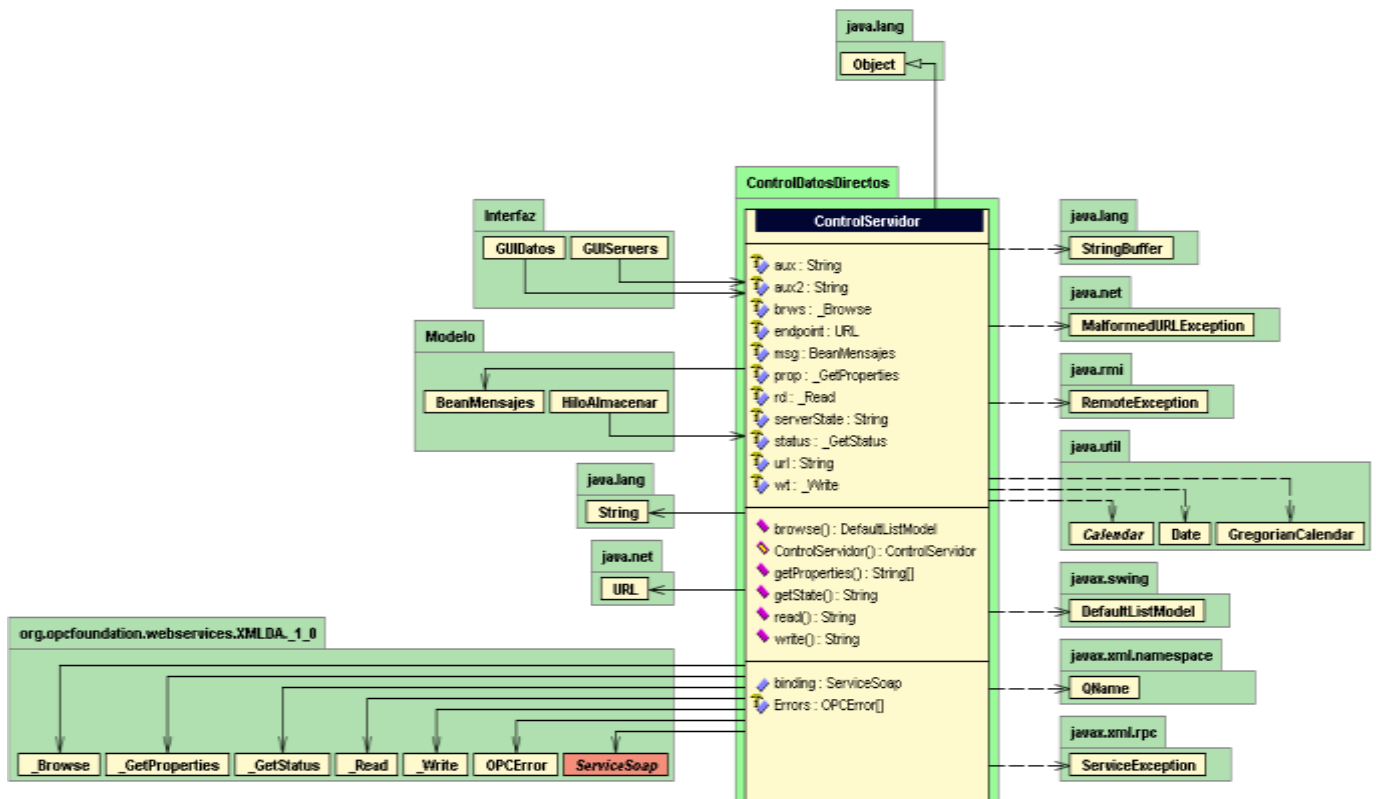



## Paquete ModeloAE:

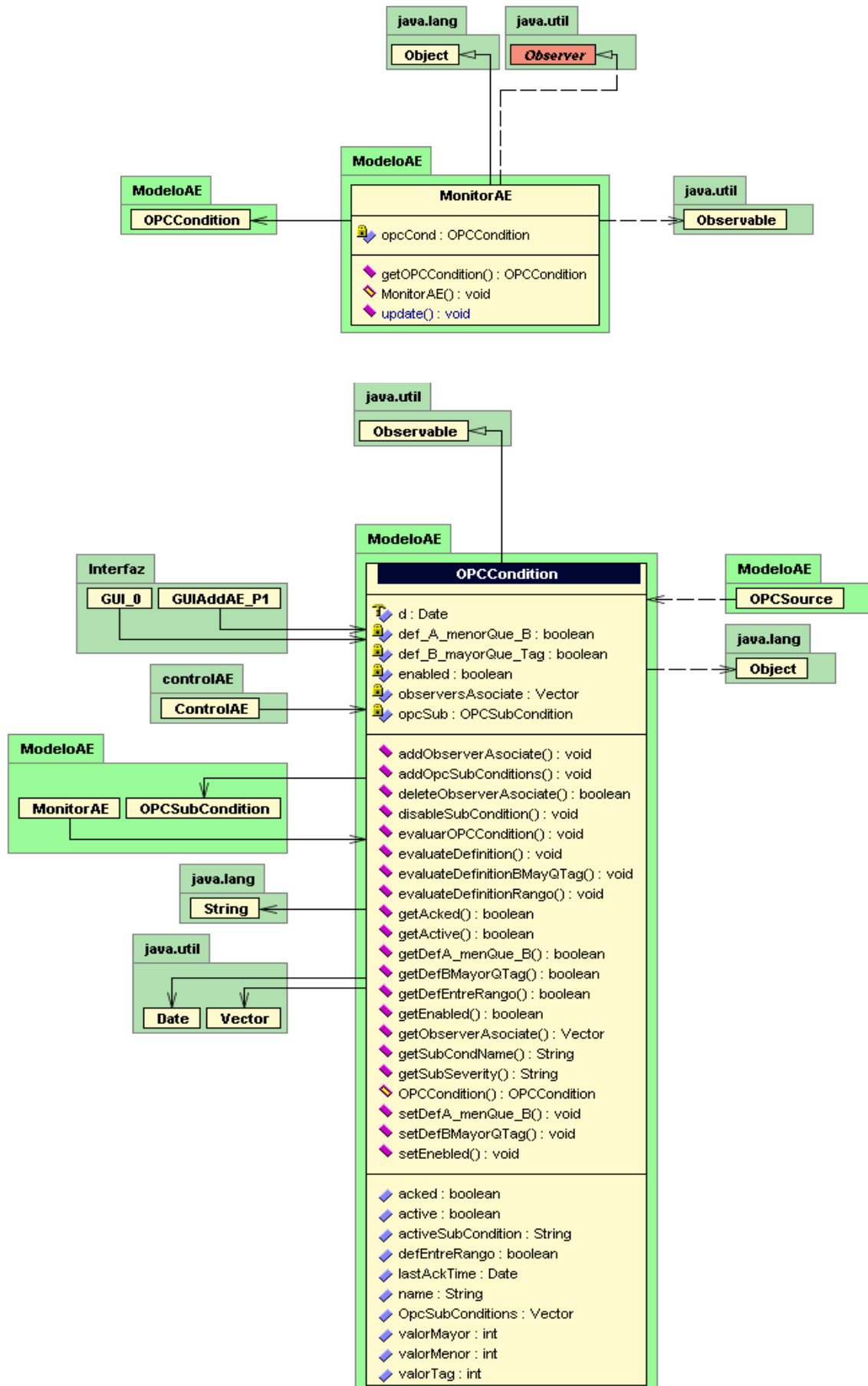

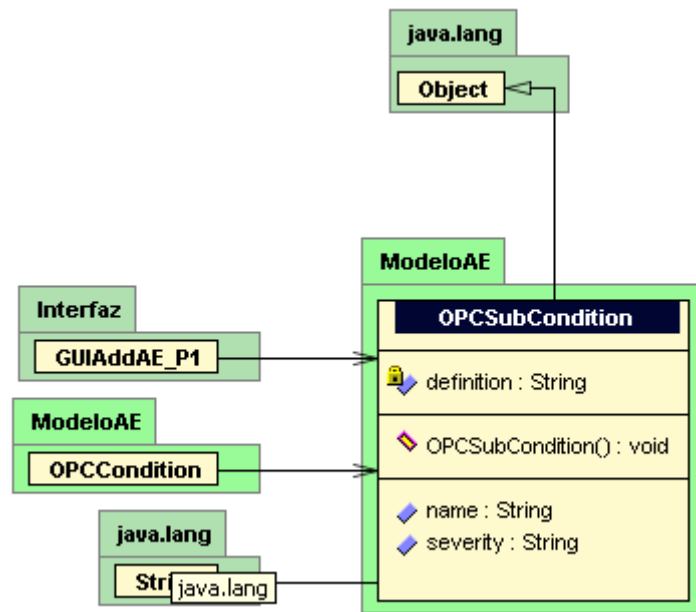

### Paquete ControlIAE:

